

# SONY

COLOR CAMERA BLOCK

## FCB-9500 Series

A new color camera block that achieves higher visibility by adopting new lens, image sensor, and ISP by Japanese manufacturer.

Experience 30x enhanced optical zoom in a compact size even with the larger 1/1.8 sensor.

The camera can be used in a wide variety of scenes, including environments with harsh conditions, in particular the new super image stabilizer has greatly improved blur suppression compared to conventional models. Select from a lineup of 3 models: 4M model (HDMI output) and full HD models (MIPI or LVDS output) in the same sized housing.



4M

### FCB-EW9500H

4M (2160p/60)  
HDMI  
30x Enhanced Optical Zoom

STARVIS

Full HD

### FCB-EV9500M

Full HD (1080p/60)  
MIPI  
30x Enhanced Optical Zoom

### FCB-EV9500L Preliminary

Full HD (1080p/60)  
LVDS  
30x Enhanced Optical Zoom

Launch schedule: First half of 2022



Conventional Model

FCB-EW9500H

#### High Resolution

Utilizing a 4M sensor and sharp lens achieve superior resolution and accurate image representation with the evolved AF/AE/AWB functions even in low light environments. Combined with enhanced optical zoom achieve a high image quality from the Wide end to the Tele end.

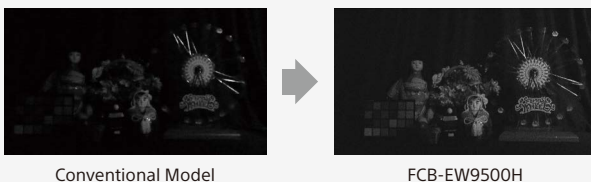

Conventional Model

FCB-EW9500H

#### High Sensitivity

Through introduction of new cell structures and circuit technology, the series efficiently uses light, achieving twice the sensitivity compared to conventional image sensors. Consequently, clear images can be captured even during the night and in dark environments.

STARVIS

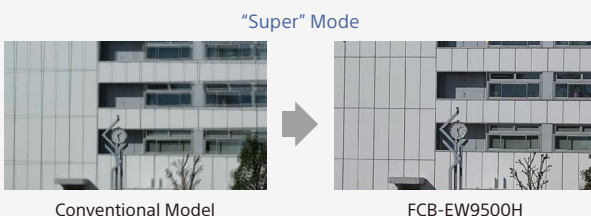

Conventional Model

FCB-EW9500H

#### Super Image Stabilizer

Enables capturing of highly precise video with reduced blurring even in harsh environments with strong vibrations by greatly improving blur suppression and image stabilizer. Equipped with the "Super" and "Super+ (plus)"\* modes.

\*Available during full HD or HD output

# Features

## 30x Enhanced Optical Zoom

Using a compact lens designed for resolutions up to 8M the camera maximizes the coverage of the 4M sensor. The newly designed lens provides high resolution and low aberration, making it capable of capturing high resolution images that span from the Tele end from the screen center to the surrounding edges.

There is no image deterioration using the 30x enhanced optical zoom. Experience full sharpness and dramatically reduced chromatic aberration in full HD output and also achieve images with sharp resolution during 4M output.

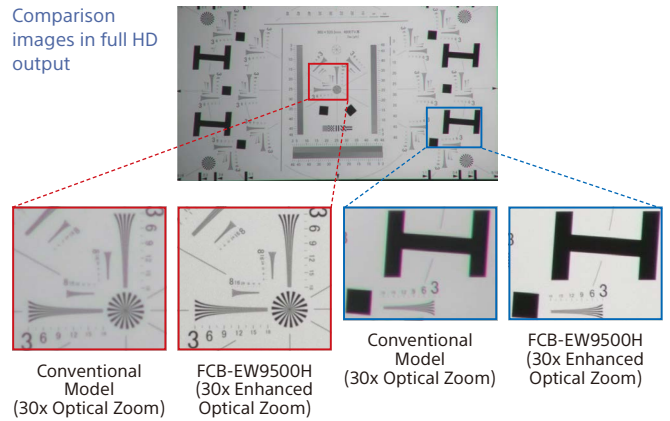

## Equipped with an approximately 417 million-effective-pixel, 1/1.8-type high sensitive, AR-coated (anti-reflective coating) CMOS sensor

**STARVIS**

With a high spectral sensitivity value in near infrared to infrared, it is especially effective for security uses.

Furthermore, the AR coating minimizes the ghost phenomenon and enables capturing of images without missing crucial information even during the night and in dark environments.

### Spectral Sensitivity

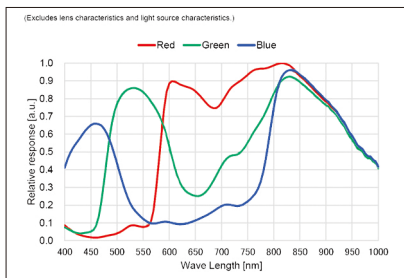

### Comparison images when 0.03lx Halogen 1/30s ICR: ON HS: OFF

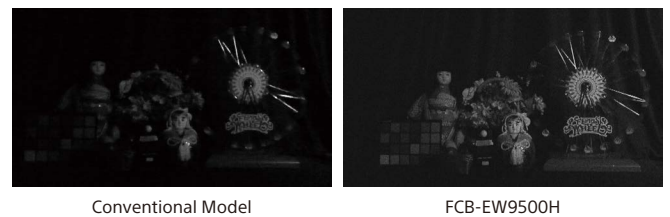

### Ghost reduction effect



## Super Image Stabilizer

Applying a wide correction area using 4M pixels the camera series suppresses blurs from strong vibrations and rotational vibrations compared to conventional models. There are 2 modes available to select from based on the scale of vibrations.

### ■ Super

Suppresses strong vibrations with a wider correction area compared to conventional electronic vibration suppressors.

### ■ Super+

By employing a wider correction area than "Super," "Super+" suppresses intense vibrations that cannot be suppressed with "Super."

**Potential application:** Shipboard, attachments for ITS surveillance, on bridges, drones, vehicles, etc.

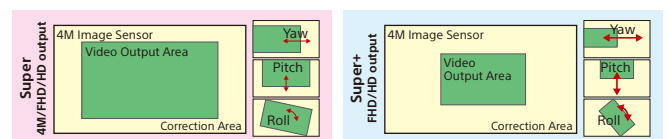

## Flare reduction with the new iris

Diamond flares and ghosts that occur on lenses disrupts focusing and deteriorates the image quality.

The new lens adopts 7 blades compared to the conventional 2 blades, improving this phenomenon by generating fine circular flares, and thus greatly improving image quality.

### 7 blades iris



### Conventional Model      FCB-EW9500H: 7 blades iris

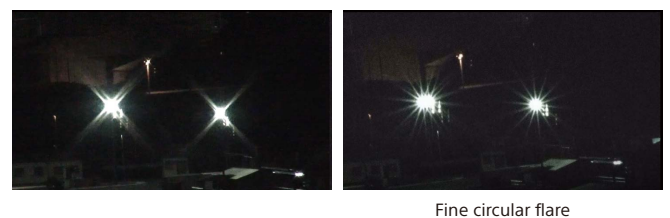

## Color image acquisition during ICR ON

On conventional models, only black and white images are achieved while the IR cut filter was removed.

The new ICR ON COLOR function enables the camera to capture shots with color even when the IR cut filter is removed. It is effective for color visibility in dark environments.

\*The precision of color reproduction varies depending on the light source and brightness.

### Comparison images when 0.03lx Halogen 1/4s ICR:ON COLOR HS:OFF

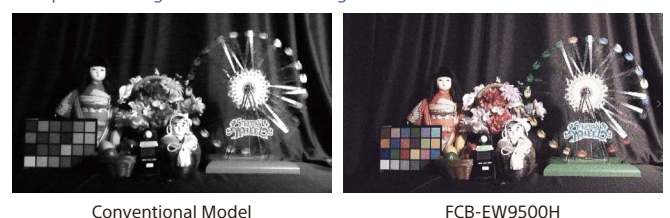

### Spot Focus · Spot AE · Spot AWB

Enables functioning of AF, AE, and AWB only in specified areas within the screen. Enables independent specification of any rectangle of the entire screen divided in 6 x 8. For example, if the subject location is specified with Spot AE, enables capturing of images with Exposure effects reduced even if brightness changes occur outside the specified frame.

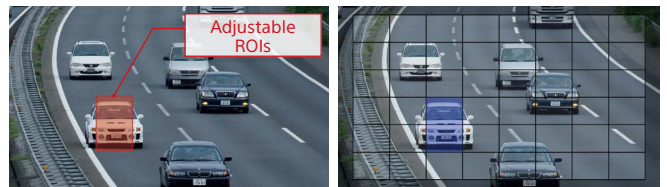

### Wide Dynamic Range (Wide-D)

Wide-D mode is a function for dividing an image into several blocks for correcting blocked-up shadows and blown-out highlights in accordance with the intensity difference. It enables image acquisition in which portions ranging from dark to light can be recognized, even when capturing a subject with a large intensity difference that is backlit or includes extremely light regions of interest.

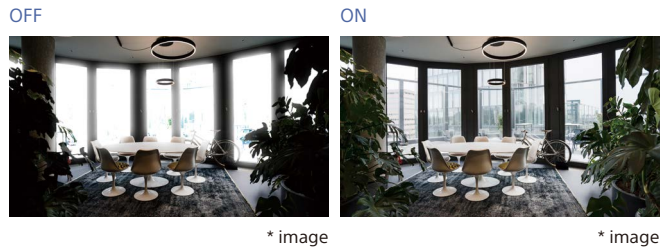

### Visibility Enhancer (VE)

Depending on the imaging scene, the Visibility Enhancer function makes the darker part of a camera image brighter, and automatically corrects brightness and contrast to show bright parts clearly.

### Low Focal Plane Distortion Image

The image warp that occurs when capturing rapidly moving subjects is reduced.

### Defog (low/mid/high)

When the surrounding area of the subject is foggy and low contrast, the defog mode will reduce the effects of the fog and make the subject appear clearer. You can select from four levels: OFF, Low, Middle and High. The effect level can be automatically adjusted according to the fog density.

### Noise Reduction (NR)

The NR function removes noise (both random and nonrandom) to provide clearer images.

### Privacy Zone Masking

Privacy Zone masking protects private objects and areas such as house windows, entrances, and exits which are within the camera's range of vision but not subject to surveillance. Privacy zone masking can be masked on the monitor to protect privacy.

- Mask can be displayed on 8 places per screen
- Individual on/off zone masking settings.

### StableZoom™

"StableZoom" is a function for performing correction using the Image Stabilizer function in accordance with the zoom ratio, and smoothly zooming up to approximately 36x using a combination of the optical zoom and digital zoom.

### Picture Effect

- E-FLIP
- Freeze
- Black & White (Monochrome Image)

### Auto ICR

Auto ICR Mode automatically switches the settings needed for attaching or removing the IR Cut Filter. With a set level of darkness, the IR Cut Filter is automatically disabled (ICR On), and the infrared sensitivity is increased. With a set level of brightness, the IR Cut Filter is automatically enabled (ICR Off). Also, on systems equipped with an IR light, the internal data of the camera is used to make the proper decisions to avoid malfunctions. Auto ICR Mode operates with the AE Full Auto setting. When the Auto ICR Color Mode is set, the color is added.

### Spot Light Avoidance

Avoid AF / One push AF focus issues when shooting a subject with a bright, spot light source, such as an outdoor light with Spot Light Avoidance.

For example, when shooting outdoors at night with a surveillance camera, the camera may not focus due to the bright light. In that situation, using the Spot Light Avoidance function, reduces the impact of bright lights and you can focus with the AF / One push AF.

### Other Functions

\* For the setting values, refer to the technical manual.

#### ■ Focus

Equipped with various focus modes.

#### ■ AE (Auto Exposure Mode)

Equipped with various modes.

#### ■ Motion Detection (MD)

This function instructs the camera to detect movement within the monitoring area and then send an alarm signal automatically.

#### ■ Custom Preset

The camera shooting conditions can be stored and recalled. The settings are recalled when the power is turned on.

#### ■ Position Preset

Using the position preset function, 16 sets of camera shooting conditions can be stored and recalled. This function allows you to achieve the desired status instantly, even without adjusting the various items each time.

#### ■ Title Display

#### ■ Temperature Readout

The camera unit's internal temperature can be read from temperature sensor installed in the circuit board. Use it as a reference value.

### Dimensions

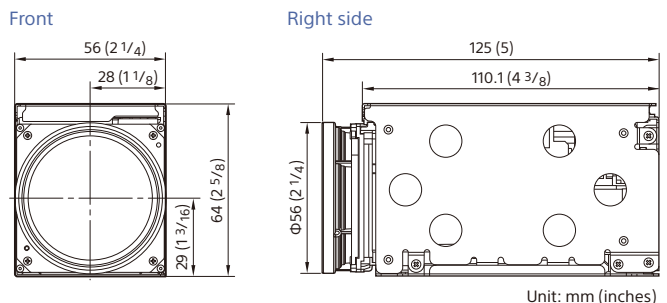

### Connector (Common to all 3 models)

#### Digital output connector

KEL Co. USL00-30L-C

Pin assignment varies by model. Refer to the technical manual for details.

#### Digital output connector

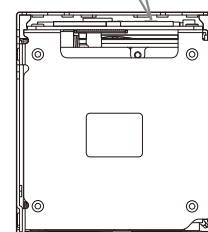

# Specifications

	FCB-EW9500H (4M · HDMI)	FCB-EV9500M (Full HD · MIPI)	FCB-EV9500L Preliminary (Full HD · LVDS)
Launch schedule: First half of 2022			
<b>Basic Specifications</b>			
Image Sensor (Number of effective pixels)	1/1.8-type STARVIS™ CMOS Sensor (Approx. 4.17M pixels)		
Output Image Size (H x V)	2688x1512 <sup>*1</sup> 2560x1440 <sup>*1</sup> 1920x1080, 1280x720	1920x1080, 1280x720	
Signal System	2160p/60, 2160p/59.94, 2160p/50, 2160p/30, 2160p/29.97, 2160p/25, 1080p/60, 1080p/59.94, 1080p/50, 1080p/30, 1080p/29.97, 1080p/25, 1080i/60, 1080i/59.94, 1080i/50, 720p/60, 720p/59.94, 720p/50, 720p/30, 720p/29.97, 720p/25	1080p/60, 1080p/59.94, 1080p/50, 1080p/30, 1080p/29.97, 1080p/25, 1080i/60, 1080i/59.94, 1080i/50, 720p/60, 720p/59.94, 720p/50, 720p/30, 720p/29.97, 720p/25	
Minimum Illumination (50%, High Sensitivity Mode ON)	ICR-Off mode: 0.009 lx (Shutter Speed: 1/30 s), 0.0012 lx (Shutter Speed: 1/4 s or 1/3 s) ICR-On mode: 0.00008 lx (Shutter Speed: 1/30 s), 0.000005 lx (Shutter Speed: 1/4 s or 1/3 s, 30%)		
Minimum Illumination (50%, High Sensitivity Mode OFF)	ICR-Off mode: 0.09 lx (Shutter Speed: 1/30 s), 0.012 lx (Shutter Speed: 1/4 s or 1/3 s) ICR-On mode: 0.00063 lx (Shutter Speed: 1/30 s)		
Recommended Illumination	100 lx to 100,000 lx		
Image S/N	50 dB(Weight On)		
Gain	Auto/Manual (0 dB to 50.0 dB), 0 to 28 steps		
Shutter Speed	1/1 to 1/10000 s, 22 steps		
Sync System	Internal		
Exposure Control	0 dB to ± 10.5 dB, 15 steps		
Backlight Compensation	Yes		
Gamma	Standard / Straight gamma		
Aperture Control	16 steps		
White Balance	Auto, ATW, Indoor, Outdoor, One Push WB, Manual WB, Outdoor Auto, Sodium Vapor Lamp (Fix/Auto/Outdoor Auto), Spot AWB		
AE (Auto Exposure Mode)	Full Auto, Manual, Priority mode (shutter/iris), EV compensation, Spot AE, Slow AE		
Zoom	30x Enhanced Optical Zoom 36x StableZoom <sup>*2,3</sup> 12x Digital Zoom	30x Enhanced Optical Zoom 36x StableZoom <sup>*2</sup> 12x Digital Zoom	30x Enhanced Optical Zoom 36x StableZoom <sup>*2</sup> 12x Digital Zoom
Lens (wide to tele)	f = 6.5 mm to 162.5 mm, F1.6 to 4.8		
Zoom Mode	Standard Mode / Variable Mode / Direct Mode		
<b>Zoom Movement Speed</b>			
Wide end to Tele end	4.8 s (Focus Tracking ON), 2.9 s (Focus Tracking OFF)		
Wide end to Digital 12x tele	6.1 s (29.97p/59.94p), 6.4 s (25p/50p)		
Digital wide to Digital 12x tele	1.4 s (29.97p/59.94p), 1.6 s (25p/50p)		
Focusing System	Auto Focus (Normal AF, Interval AF, Zoom Trigger AF [Sensitivity: normal, low]), Manual (Standard, Variable, Direct), One Push Trigger, Full Scan One Push Trigger, Near Limit, ICR-on Correction, Spot Focus		
Focus Movement Time	∞ to Near: 1.4 s		
Horizontal Viewing Angle	58.1° to 2.3°		
Minimum Object Distance (wide end to tele end)	100 mm to 1200mm		
<b>Camera Features</b>			
Auto ICR	Yes		
Wide Dynamic Range (Wide-D)	Yes		
Visibility Enhancer	Yes		
Defog	Yes (low/mid/high)		
Noise Reduction	Yes (3D + 2D / Independent setting (3D, 2D))		
Progressive Scan Mode	Yes		
Image Stabilization	Yes: Super image stabilizer (Super / Super+ <sup>*3</sup> )		
Spot Light Avoidance	Yes		
Motion Detection	Yes		
Privacy Zone Masking	Yes		
Alarm	Yes		
Slow AE Response	Yes		
Picture Effects	Black White (Monochrome Image)		
Picture Freeze	Yes		
Electronic-Flip (E-FLIP)	Yes		
Mirror Image	Yes		
Slow Shutter	Yes		
Temperature Readout	Yes		
Title Display	Yes (20 characters / line, max. 11lines)		
Camera Mode Display	Yes (English)		
<b>Interface</b>			
Video Output	Digital : Y/Pb/Pr 4:2:2 (HDMI) Y:8bit, C:8bit RGB 4:4:4 (HDMI) R:8bit G:8bit B:8bit	Digital : Y/Pb/Pr 4:2:2 (MIPI) Y:8bit, C:8bit RGB 4:4:4 (MIPI) R:8bit G:8bit B:8bit <sup>*4</sup>	Digital : Y/Pb/Pr 4:2:2 (LVDS) (Y: 8 bit, C: 8 bit, Vsync, Hsync, Field, Clock) (SMPTE274M/SMPTE296M)
Camera Control Interface	VISCA protocol (CMOS 3.3V Level, 5.5V tolerance); Baud Rate : 9.6 kbps, 19.2 kbps, 38.4 kbps, 115.2 kbps, Stop bit: 1 bit		
<b>General</b>			
Power Requirements	7.0 V to 12.0 V DC		
Power Consumption	4.6 W (When motor operates: 6.3W)	5.0 W (When motor operates: 6.8W)	6.1 W (When motor operates: 7.8W)
Operating Temperature	-5 °C to +60 °C (23 °F to +140 °F)		
Storage Temperature	-20 °C to +60 °C (-4 °F to +140 °F)		
Operating Humidity	20% to 80% (Absolute humidity: 36 g/m <sup>3</sup> )		
Storage Humidity	20% to 95% (Absolute humidity: 36 g/m <sup>3</sup> )		
Dimensions (W x H x D)	56.0 x 64.0 x 125 mm (2 1/4 x 2 5/8 x 5 in.)		
Mass	Approx. 439 g (15 oz.)		

<sup>\*1</sup> The 2688 x 1512 or 2560 x 1440 image with surrounding black frame is output in 2160p signal system.

<sup>\*2</sup> StableZoom increases the magnification by combining optical zoom and digital zoom.

<sup>\*3</sup> FCB-EW9500H: For 1080p, 1080i, and 720p only.

<sup>\*4</sup> Y/Pb/Pr is not supported for 1080i/60, 1080i/59.94, 1080i/50.

Distributed by

©2021 Sony Corporation

Reproduction in whole or in part without written permission is prohibited.

Features and specifications are subject to change without notice.

The values for mass and dimensions are approximate.

SONY is a registered trademark of Sony Group Corporation.

STARVIS and StableZoom are trademarks of Sony Group Corporation or its affiliates.

All other trademarks are the property of their respective owners.

Please visit Sony's professional website or contact your Sony representative for specific models available in your region.